





# QUICK REFERENCE GUIDE

---

## Light Replacement Guide



 Spa Electric<sup>®</sup>

spaelectrics.com |    

*retro*<sup>®</sup>

REPLACEMENT LED POOL LIGHT

# PRE-INSTALLATION CHECK

## 1. CHECK POWER SUPPLY

A 12V AC Transformer **MUST** be installed between the 120V power supply and pool light. Do **NOT** continue installation if directly connected to 120V power.

DO **NOT** CONTINUE INSTALLATION IF DIRECTLY CONNECTED TO 120V POWER.

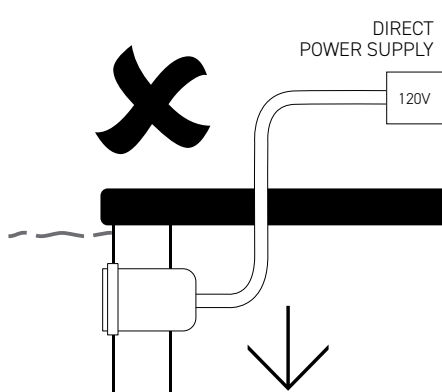

IF THERE IS AN EXISTING TRANSFORMER, CHECK THAT IT MEETS THE SPECIFICATIONS LISTED BELOW IN STEP 2.

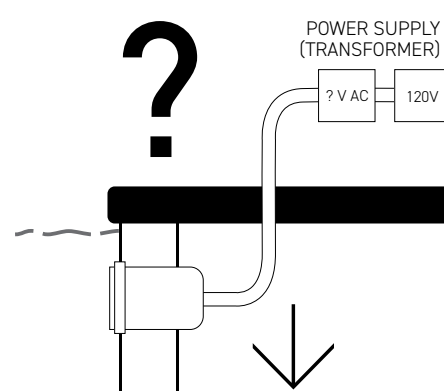

## 2. ADD A TRANSFORMER

TRANSFORMER REQUIRED SPECIFICATION:

- UL Listed Isolating Low Voltage power supply, evaluated for swimming pool use
- Installed as per current NEC wiring rules
- 12-14V AC output
- Minimum Wattage requirement per light. See Step 2a.
- In good working order

TRANSFORMER MUST **NOT** BE:

- DC or 'LED Driver'
- Electronic or Switch mode
- Weather damaged or in otherwise poor condition.

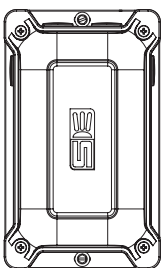

Spa Electrics recommends "**LVX**" safety transformers or LITYARD Control System for use with **Retro Universal** lights.

Available Models:  
LVX50  
LVX50P  
LVX100  
LVX100P  
LITY2XRFHCA

## 2a. WATTAGE REQUIREMENT



R6, R1, EMRX: 15W PER LIGHT

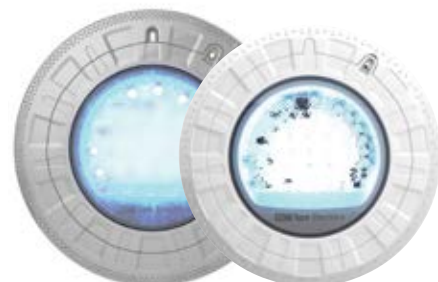

R10, R8: 45W PER LIGHT

### 3. CHECK CABLE THICKNESS

Retro Universal can fit cables from 9/32" (7mm) up to 9/16" (14mm) diameter



### 4. CHECK BONDING

Ensure bonding is secure at the back of the niche.

**DO NOT CUT** the bonding cable. **DO NOT DISTURB** the bonding cable when working with the plug cable.

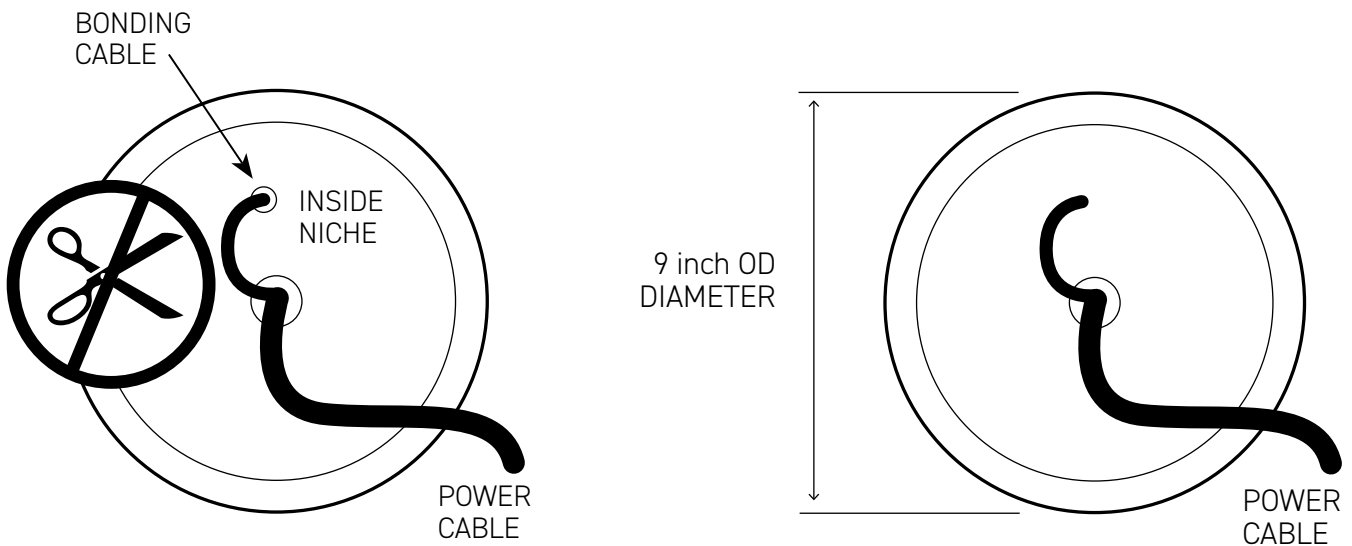

### 5. CHECK NICHE DIAMETER

Retro Universal lights are designed to work with various diameter niches. Please refer to the table below for niche/pipe diameter and the recommended Retro Fit options.

NICHE DIAMETER AND RETRO-FIT OPTION	
Niche/Pipe Diameter (inch)	Recommended Retro-Fit
9.0" – 9.6"	R10
7.4" – 8.1"	R8
4.6" – 5.2"	R6 with standard Cam Locks
5.8" – 6.6"	R6 with Q500 Cam Locks(sold separately) - PN: R6C 006 Q5 CA
1.5" thread fitting	R1

# EMRX RETRO FITS

 Click here for installation instructions

## EMRX SERIES FOR EXISTING AQUA/LAMP®

LIGHTS & MOUNTING KIT		
Pool Type	LED Option	Product Code
CONCRETE & VINYL POOLS	1x EMRX Multi Plus Light & White Aqualamp Adaptor	EMRX L12 R2 GMPL
	1x EMRX Multi Plus Light & Grey Aqualamp Adaptor	EMRX L12 R2 WMPL



EMRX RETRO FITS WITH AQUA/LAMP®	
Light Model	Dimension
Aqua/Lamp® (Verified)	1.5" diameter 5 1/2" long



# R1 RETRO FITS

[Click here for installation instructions](#)

## R1 SERIES 1.5" THREADED RETRO LIGHTS

### LIGHTS & MOUNTING KIT

Pool Type	LED Option	Rim Color	Product Code
CONCRETE & VINYL POOLS			
X1 Argon Light + Adaptor Plate + Plug Kit	Multi Plus	Clear	R1 L12 C1 CMP

### REPLACEMENT BULBS INCLUDES 1X 6" LIGHT

Pool Type	LED Option	Rim Color	Product Code
CONCRETE & VINYL POOLS			
1x Argon Light + Clear Rim	Multi Plus	Clear	N3 L12 C0 CMP

Will Fit existing 1.5" threaded fittings.

Examples:

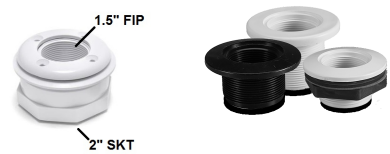

### R1 RETRO FITS WITH THREADED 1.5INCH FITTING BRACKET

Light Model	Dimension
Jandy WaterColors Nicheless LED lights (not if using vinyl/fibreglass GloBrite niche)	1.5" diameter 5 1/2" long
Hayward Return Light (Colour Logic or Crystal Logic) *Must be installed in a threaded return fitting	1.5" fitting
MicroBrite® Color and White LED Lights	1.5" fitting
BRIO LED Light 3"	1.5" return fitting
MINI-BRIO Mini LED Light	1.5" return fitting
SAVI Note <u>NEXXUS</u> LED Underwater Nicheless Pool Light	1-1.5" fitting
CMP Brilliant Wonders® 1.5" LED Light	1.5" fitting 4-4.5" depth
S.R Smith Micro LED Pool Light (only if the light fitting has not been removed)	1.5" PVC custom fitting which is supplied with the light



# R6 RETRO FITS



## R6 SERIES 6" RETRO LIGHTS

LIGHTS & MOUNTING KIT <small>CHOOSE YOUR LIGHT OPTION, UNIVERSAL ADAPTOR &amp; RIM COLOR</small>			
Pool Type	LED Option	Rim Color	Product Code
CONCRETE & VINYL POOLS 1x Retro 6" (R6) Light + 6" Niche Adaptor + Plug Seal Assembly + Rim	Multi Plus	White	R6C L12 C1 WMP
		Grey	R6C L12 C1 GMP

REPLACEMENT BULBS <small>INCLUDES 1X 6" LIGHT</small>		
Pool Type	LED Option	Product Code
CONCRETE & VINYL POOLS	1x Argon 3" Multi Plus Light	N3 L12 C0 CMP

Will Fit Existing Niches with Inner Diameter of:

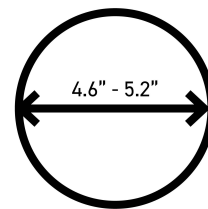

(Standard Kit)

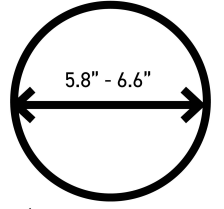

(With R6006Q5CA Cam-Locks)

### R6 WITH STANDARD R6 BRACKET

Light Model	Dimension	Spare Part
Pentair Plastic Niche (Small) 79206600	5.3"	
Pentair Sta-Rite Sunlite 05607		
Jandy ProNiche PL - Small, PLNICSM -	5.2"	
Hayward ULC Series Underwater Small Lighting Niche	6.5"	
Hayward DuraNiche™ SP0607U, SP0608U and SP0601U	4.6"	R6 Vinyl Dress Ring
Hayward AstroLite™ II Series Spa Lighting SP0590 series	5 3/8" (outside diameter of face rim)	



Part Numbers for Vinyl Dress Rings:  
R6V0021CAWH - White  
R6V0021CAGY - Grey

# R6 RETRO FITS (CONTINUED)

## R6 WITH STANDARD R6 BRACKET

Light Model	Dimension
Hayward AstroLite™ II Series Spa Lighting SP0590 series	5 ¼" (outside diameter of face rim)
IntelliBrite® 5G Color and White LED Pool Lights	6"
Blue Square Spectrum 360	N/A



## R6 WITH Q500 CAM LOCKS

Light Model	Dimension	Spare Part
Jacuzzi Q500 Underwater Pool Light	6"	R6 006 Q5 CA



**\*IMPORTANT** - A transformer, such as LVX or LitYard2 system will need to be added when replacing existing high voltage (120V) lights

# R8 RETRO FITS



## R8 SERIES 8" RETRO LIGHTS

### LIGHTS & MOUNTING KIT CHOOSE YOUR LIGHT OPTION, UNIVERSAL ADAPTOR & RIM COLOR

Pool Type	LED Option	Rim Color	Product Code
<b>CONCRETE &amp; VINYL POOLS</b>	Multi Plus	White	<b>R8C L12 C1 WMP</b>
		Grey	<b>R8C L12 C1 GMP</b>
1x Retro 8" (R8) Light + 8" Niche Adaptor + Plug Seal Assembly Kit + Rim	White 4000k	White	<b>R8C L12 C1 WW4</b>
		Grey	<b>R8C L12 C1 GW4</b>
	White 3000k	White	<b>R8C L12 C1 WW3</b>
		Grey	<b>R8C L12 C1 GW3</b>

Will Fit Existing Niches with Inner Diameter of:

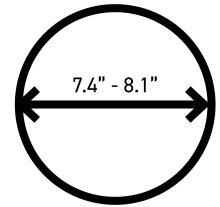

### REPLACEMENT BULBS INCLUDES 1X 10" LIGHT

Pool Type	LED Option	Product Code
<b>CONCRETE &amp; VINYL POOLS</b>	1X Retro 10" (R10) Multi Plus Light	<b>R10 L12 C0 MP</b>
	1X Retro 10" (R10) White 4K Light	<b>R10 L12 C0 W4</b>
	1X Retro 10" (R10) White 3K Light	<b>R10 L12 C0 W3</b>

### R8 RETRO-FIT WITH R8 BRACKET

Light Model	Dimension	Spare Part
Pentair – Sta-Rite SwimQuip Pool Light P/N 78244200 & 78241202  i). P/N 7824200 ii). P/N 78241202	8"	
HAYWARD PROSERIES	8.5"	N/A





# R10 RETRO FITS



## R10 SERIES 10" RETRO LIGHTS

### LIGHTS & MOUNTING KIT CHOOSE YOUR LIGHT OPTION, UNIVERSAL ADAPTOR & RIM COLOR

Pool Type	LED Option	Rim Color	Product Code
<b>CONCRETE &amp; VINYL POOLS</b>	Multi Plus	White	<b>R10C L12 C1 WMP</b>
		Grey	<b>R10C L12 C1 GMP</b>
1x Retro 10" (R10) Light + 10" Niche Adaptor + Plug Seal Assembly Kit + Rim	White 4000k	White	<b>R10C L12 C1 WW4</b>
		Grey	<b>R10C L12 C1 GW4</b>
	White 3000k	White	<b>R10C L12 C1 WW3</b>
		Grey	<b>R10C L12 C1 GW3</b>

Will Fit Existing Niches with Inner Diameter of:

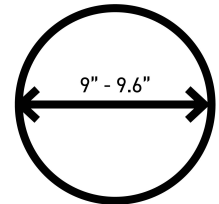

### REPLACEMENT BULBS INCLUDES 1X 10" LIGHT

Pool Type	LED Option	Product Code
<b>CONCRETE &amp; VINYL POOLS</b>	1x Retro 10" (R10) Multi Plus Light	<b>R10 L12 C0 MP</b>
	1x Retro 10" (R10) White 4K Light	<b>R10 L12 C0 W3</b>
	1x Retro 10" (R10) White 3K Light	<b>R10 L12 C0 W4</b>

### R10 RETRO-FIT WITH R10 BRACKET

Light Model	Dimension	Spare Part
IntelliBrite® 5G Color and White LED Pool Lights	10"	N/A
Intellibrite® Architectural Series	10"	N/A
Pentair 78210300 Stainless Steel Niches	10"	N/A
Pentair 79206700 Plastic Niches	10"	N/A
Jandy Large Stainless Steel ProNiche SSNICLRG1R	10"	N/A
Jandy® Large White Incandescent Light	10" diameter 5.01" depth	N/A



# R10 RETRO FITS (CONTINUED)

R10 RETRO-FIT WITH R10 BRACKET		
Light Model	Dimension	Spare Part
Jandy® Commercial Large White LED Light	10.04" diameter 3.24" depth	N/A
Pentair Amerlite® Underwater Incandescent Light	10.12" diameter 7.72" depth	
Large Plastic Niche, Gunite Pool Light PLNICLRG	9.85"	
Hayward Large Niche-Gun/Con SS 1/2 REA		
Hayward DuraNiche SPX9607UC/SP0607U (Vinyl)		R10 Vinyl Dress Ring 2
Hayward Plastic Niche – Vinyl Pool SP0508A (Vinyl)		R10 Vinyl Dress Ring 2
Pentair Stainless Steel Niche 78232500 (Vinyl)		R10 Vinyl Dress Ring 3
Pentair Quick Niche ASY 620004 (Vinyl)		R10 Vinyl Dress Ring 1



# R10 RETRO FITS (CONTINUED)

## R10 RETRO-FIT WITH R10 BRACKET

Light Model	Dimension	Spare Part
Hayward ColorLogic 4.0 LED Pool & Spa Lights	N/A	N/A
J&J Electronics INC. XG-W Series SwimQuip Version Light fits into existing large niches with similar mounting dimensions to Jandy PLNICLRG	N/A	N/A
Pooltone™ Standard 16 Color Led Pool Light	10"	N/A
Jacuzzi Full Moon Pool Light	10 ½"	N/A
Hayward AstroLite Pool Lighting	N/A	N/A
S.R. Smith kēlo®XL Light fits into existing large niches with similar mounting dimensions to Jandy PLNICLRG	10"	N/A

## R10H RETRO FIT WITH R10H ADAPTOR

Light Model	Dimension	Spare Part
Hayward Universal ColorLogic® and CrystaLogic™ (Shallow Niche)	N/A	R10H Adapter

Part Numbers for Vinyl Dress Rings:

- R10V0021CAWH - White
- R10V0021CAGY - Grey



# COULDN'T FIND THE LIGHT YOU'RE LOOKING FOR?

## FOLLOW THESE SIMPLE STEPS

- 1** Turn off power, remove light from pool wall and measure the opening of niche. Important: Inner dimension of the opening/light housing is needed to confirm the proper fit.
- 2** Still can't find it? Take photos of the existing light and transformer and email [info@selectpoolproducts.ca](mailto:info@selectpoolproducts.ca)
- 3** We are here to help. Call 1-855-881-0889 or email [info@selectpoolproducts.ca](mailto:info@selectpoolproducts.ca). You can also visit [www.selectpoolproducts.ca/retro](http://www.selectpoolproducts.ca/retro) for more information on the Retro Series range.